

1. Turn on power button at back of machine on base (allow 20 sec. for boot-up).
For Initial setup follow the on-screen prompts
2. Choose "Shoot Now"
3. Pick the locations to be thrown to by touching the screen and drag and drop the ball anywhere on the court.
4. Select the Number of shots per spot.
5. Select the time between throws.
6. Push the green Start button to begin shooting.

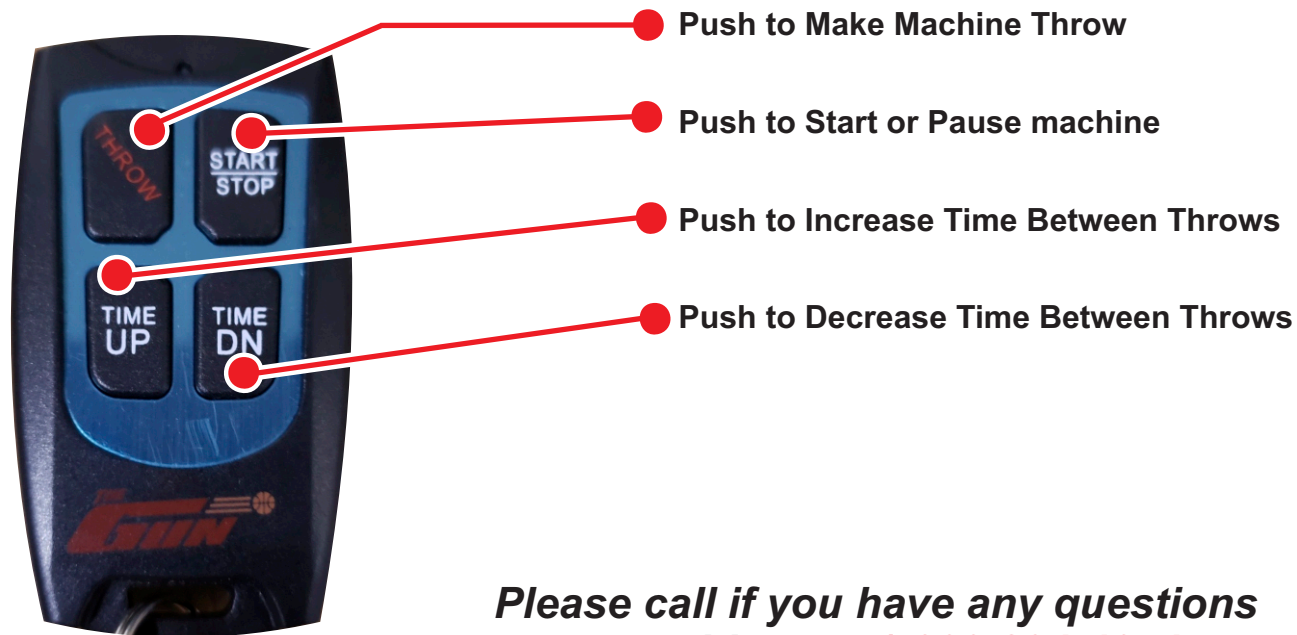

Remote Control Functions



Please call if you have any questions or problems. **1-800-294-4654**



Setup and Operation Manual



The Gun is shipped fully assembled and ready to go. All you need is an extension cord.

Caution: Plug unit in with one extension cord. Multiple light duty cords will burn up motor.

Caution: Do not put hands in throwing box! Unit could trip and cause injury. Do not leave unit plugged in and unsupervised.

Do not use black or multi-colored balls in this machine.

We only want Happy Customers!
If you have any problems or questions,
give us a call at **1-800-294-4654**

Step 1.

Extend Silver Poles

Extend 4 Silver Poles (highlighted in yellow)

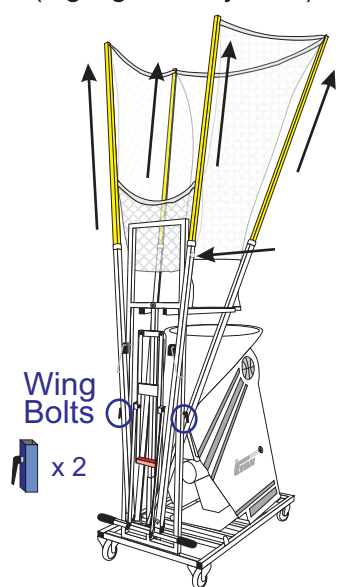

Make sure 2 wing bolts are tight. (at blue circles)

Pull silver net poles out until silver pop pin snaps in place to hold pole up.

Step 2. Raise Net Poles and Expand Net

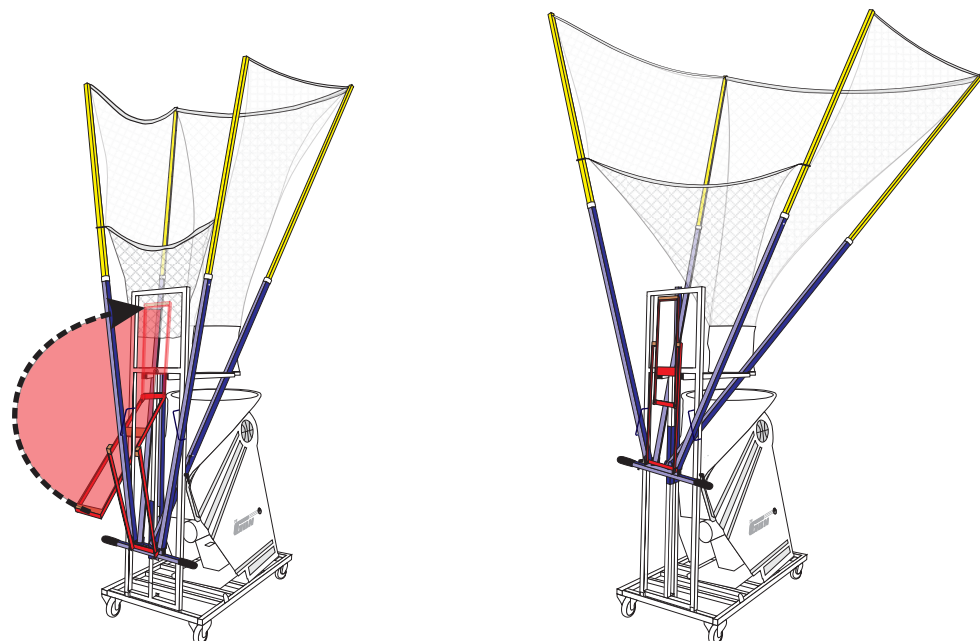

To Raise and spread net, swing lift handle up (shown at left in red) until it is in a vertical position with hand grip at top of machine. (shown at right above) A magnet on the cross piece of machine back will hold the lift arm up in the vertical position.

Note: Be sure to adjust net height as described in Step 3 below before using machine.

Mount Wand to Count Shots Made

After the unit is set up, lift the wand by its handle and hang on rim bracket as shown in diagram below. The silver pole should be straight up and down and the eye should have a clear view under the steel of the rim.

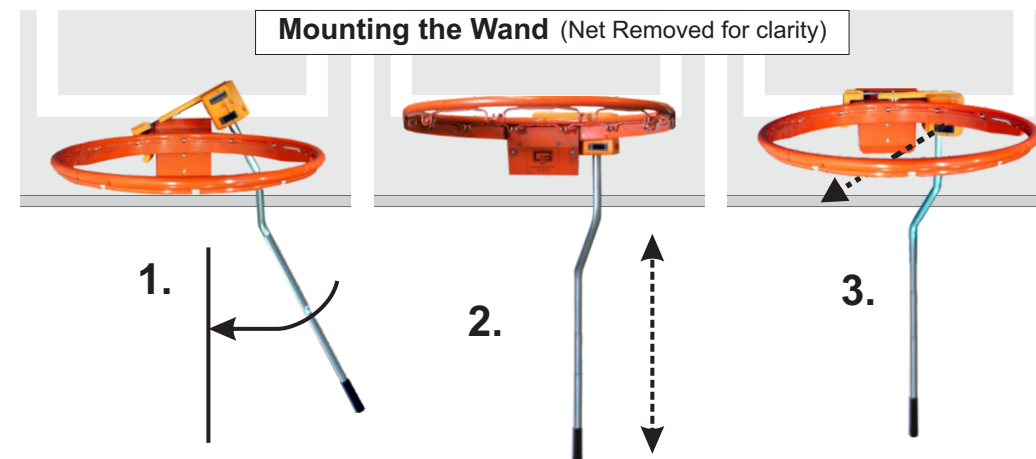

1. Place wand so hook is over rim bracket.
2. Pull down on wand handle to pull photo eye below rim edge.
3. Make sure wand handle is straight and eye is below rim and pointed toward center of rim.

Step 3. Adjust Net Height

Net height is now at it's lowest height of 10'11". This will not catch all missed shots. To raise net height, loosen 2 wing bolts and lift handles to raise the net and all the poles. The machine below on the right has been raised approximately 14". As you can see, the back of the net is bowing under the rim, which is fine. Normal height to raise unit is 1 foot, but it can be raised as much as 22". After raising net, tighten 2 wing bolts.

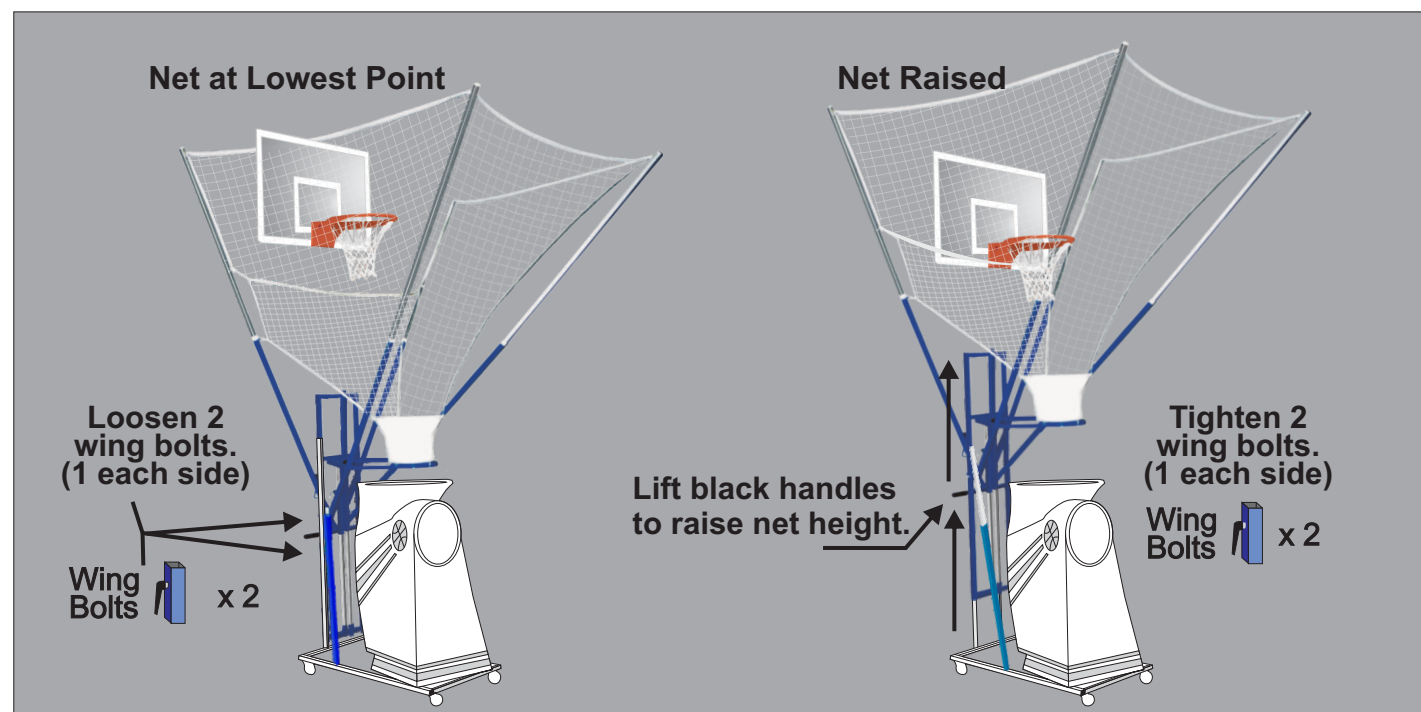

Unit is now ready to be used. Connect unit to power with a single, heavy gauge extension cord. Multiple, light duty cords may cause damage to machine.

Take Down - Storage

Photo Eye Storage

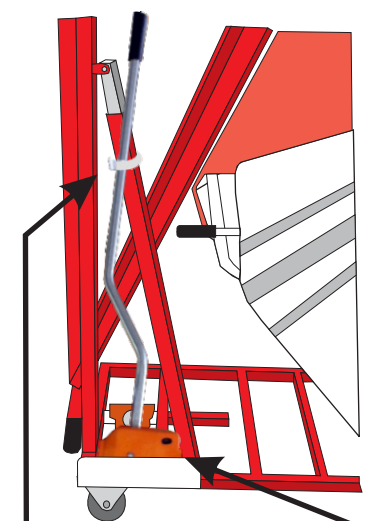

Wrap velcro around square pole and round tube to secure

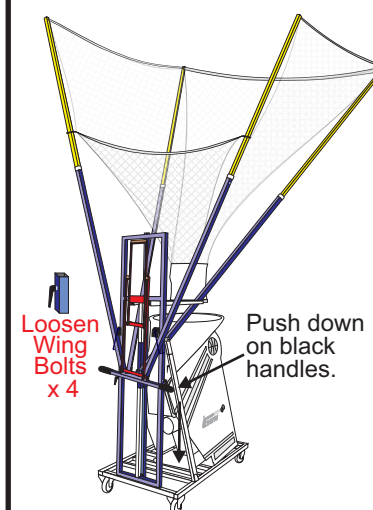

1. Loosen 2 wing bolts
2. Push down on handle until frame hits base.
3. Tighten 2 wing bolts to hold frame down.

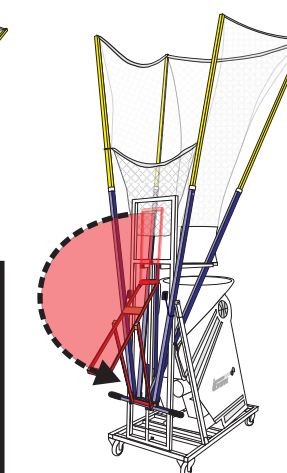

Pivot net lift handle down to lower all painted net poles.

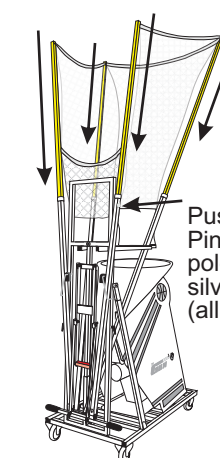

On each pole, push in silver pin and shake pole to lower the silver net poles.